A modern L-shaped sofa with orange and yellow upholstery and a black ottoman. The sofa is composed of several modular sections. The backrest and armrests are upholstered in a vibrant orange fabric, while the seat cushions are in a bright yellow fabric. A black ottoman is attached to the end of the sofa. The sofa is set on a light gray carpet in a minimalist room with a white wall.

**Designed for Comfort . Built for collaboration**

**WINTECH®**

**2025**  
Sofa Series



Wintech's new venture into sofa design complements its signature acoustic pod, creating a perfect set for open-space environments. This combination offers both openness and privacy, delivering the best user experience. By selecting premium materials and ensuring high-quality craftsmanship, the sofa delivers exceptional comfort and durability—built to withstand everyday use while enhancing any modern workspace, lounge and more area.

WINTECH®

# 3C Fabric

**3C-TEX** specializes in engineering **functional fabrics** tailored for performance-driven applications, such as outdoor gear and athletic wear, with properties like water resistance, breathability, and comfort. Committed to **sustainability**, they innovate with recycled materials and bio-mass alternatives to reduce environmental impact.

The company emphasizes **customization**, collaborating closely with clients to develop bespoke textile solutions for unique requirements. With a **global presence**, 3C-TEX actively engages in international industry events to showcase innovations, connect with trends, and strengthen partnerships worldwide.

**4000**  
*knit*



# Waterproof

The sofa's high-performance fabric is expertly engineered for effortless maintenance and cleaning, incorporating a durable waterproof barrier that actively repels liquids, stains, and spills—from coffee and wine to food accidents—while preserving its pristine appearance over years of use. This advanced material ensures worry-free living, offering peace of mind for families, pet owners, or busy households seeking to protect their investment in style and comfort



**Safe  
and  
Clean**  
ANTIBACTERIAL



**COWR**



The innovative **MDF Carb P2** composite—a lightweight, high-strength panel infused with 42% recycled carbon fiber—offers exceptional durability and eco-friendly performance for modern furniture and architectural applications.

# MDF Carb P2



**2 YEARS  
WARRANTY**

# 42 High Density Foam

This sofa features a 2-year warranty against foam deformation, ensuring long-lasting shape retention and structural integrity for enduring comfort.



| Alcova - Solo  
series

# Alcova - Solo



ALCOVA-SOLO c/w Side table with Wire management and panel  
Size: Size:1020/950mm-Lx750/700mm-Wx1350/735mm-HT  
Fabric : Forte

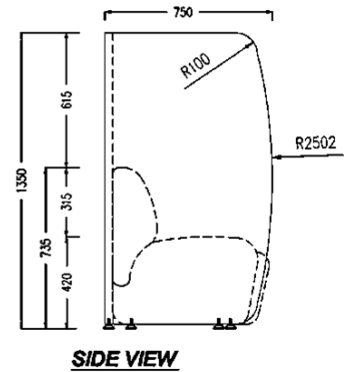
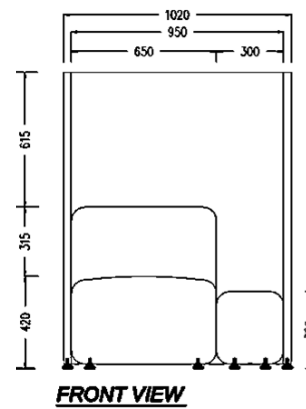
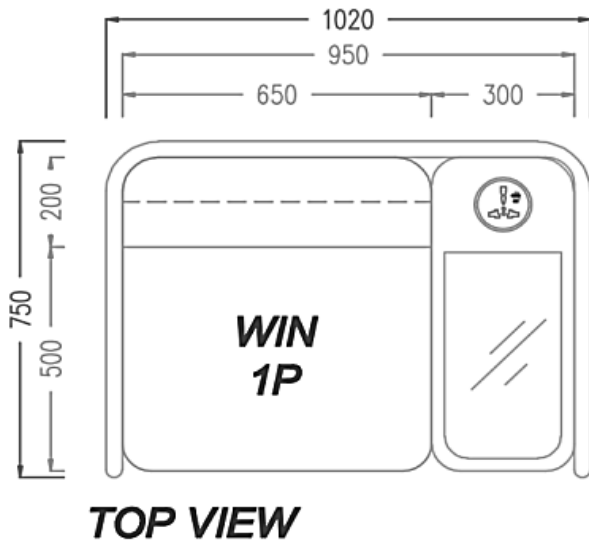



| Alcova - Duo  
series

# Alcova - Duo



ALCOVA-DUO

Size: 1380/1300mm-L x 750/700mm-W x 1350/735mm-HT

Fabric : Forte

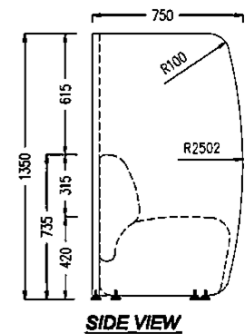
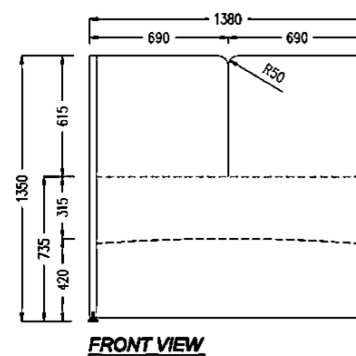
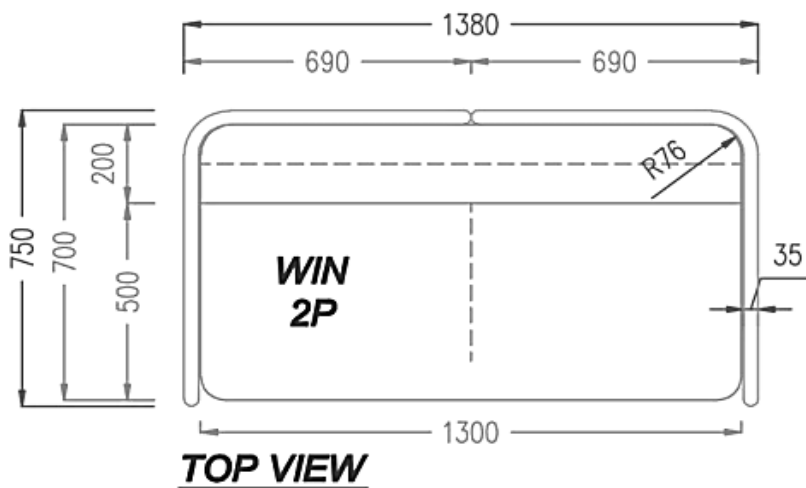



| Alcova – Team Box  
series





| Anello  
series

# Anello



**ANELLO Single Center**

**Size: 650mm-L x 700mm-W x 735mm-HT**

**Fabric : Forte**



**ANELLO Double Seater Center**

**Size: 1300mm-L x 700mm-W x 735mm-HT**

**Fabric : Forte**



**ANELLO Single Seater ( Right )**

**Size: 750mm-L x 700mm-W x 735mm-HT**

**Fabric : Forte**



**ANELLO Single Seater ( Left)**

**Size: 750mm-L x 700mm-W x 735mm-HT**

**Fabric : Forte**



**ANELLO Single Seater Right ( Corner )**

**Size: 700mm-L x 700mm-W x 735mm-H-HT**

**Fabric : Forte**

# Anello



ANELLO Single Seater arm chair  
Size: 850mm-L x 700mm-W x 735mm-H-HT  
Fabric : Forte



ANELLO Double Seater Arm Chair  
Size: 1500mm-L x 700mm-W x 735mm-HT  
Fabric : Forte

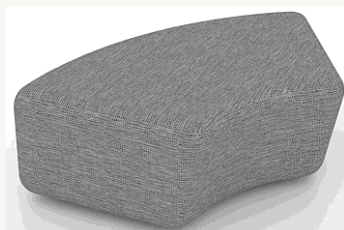

ANELLO Double Seater Bench- Curve  
Size : 1300/600mm-L x 700mm-W x 420mm -HT  
Fabric : Forte



ANELLO Single Seater Bench  
Size: 650mm-L x 700mm-W x 420mm-H  
Fabric : Forte



ANELLO Double Seater Bench  
Size: 1300mm-L x 700mm-W x 420mm-HT  
Fabric : Forte

# Anello



ANELLO Double Seater Small Curve  
Size: 600/1300mm-L x 700mm-W x 735mm-HT  
Fabric : Forte



ANELLO Double Seater Big Curve  
Size: 1300/600mm-L x 700mm-W x 735mm-H  
Fabric : Forte

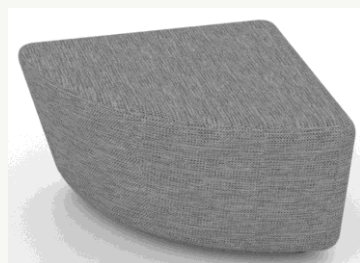

ANELLO Single Seater Bench- Triangle  
Size: 700mm-L x 700mm-W x 420mm-HT  
Fabric : Forte

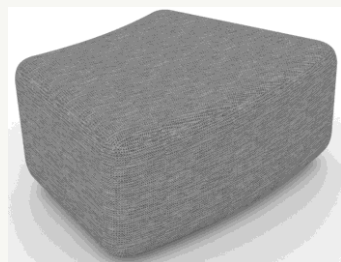

ANELLO Single Seater Bench- Curve  
Size: 700mm-L x 700mm-W x 420mm-HT  
Fabric : Forte

# Anello

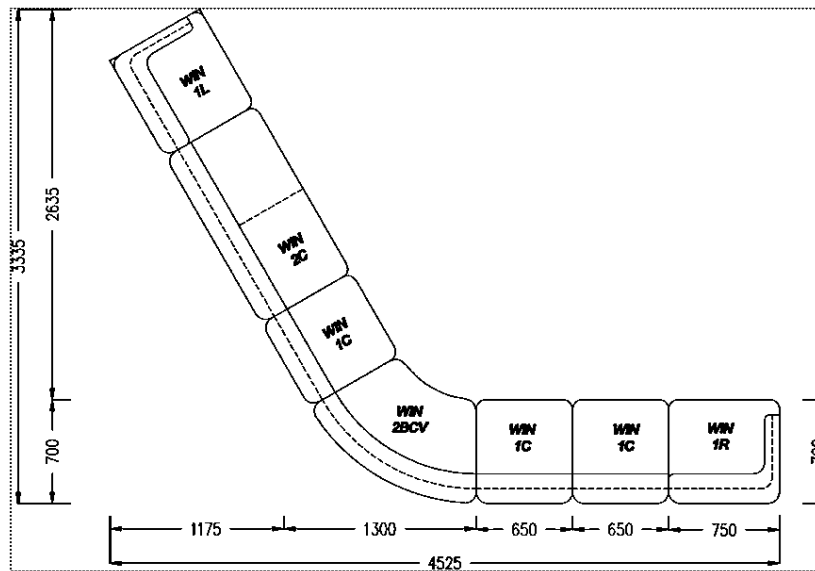
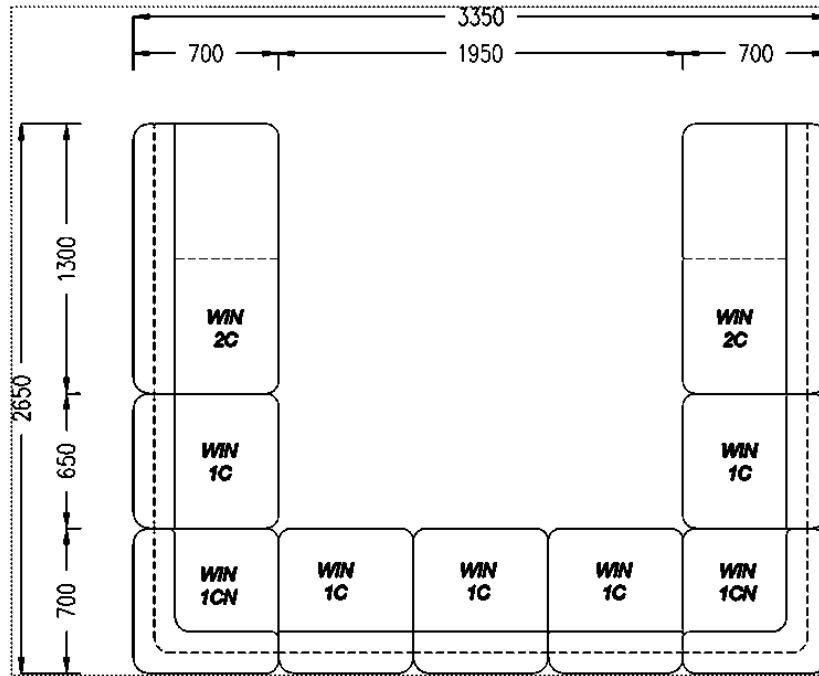



# Wireless Charge

Optional with Wireless Charging Function

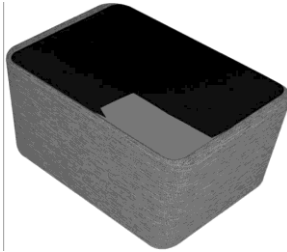

ANELLO Side Table without wire management ( glass top )

Size: 450mm-L x 700mm-W x 350mm-HT

Fabric : Forte

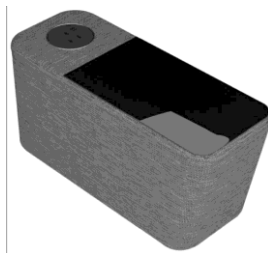
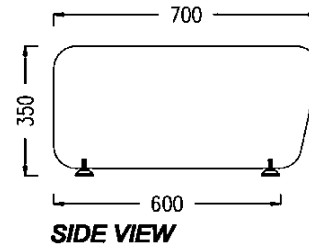
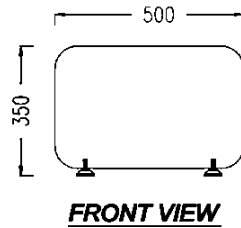
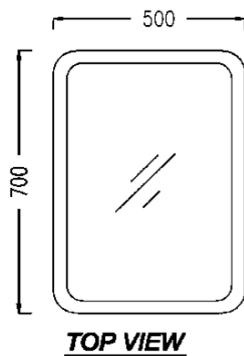

ANELLO Side Table with wire management

Size: 300mm-L x 700mm-W x 350mm-H

Fabric : Forte

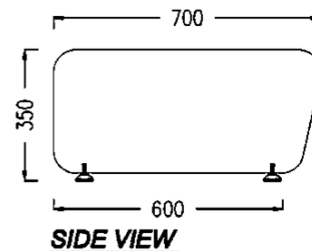
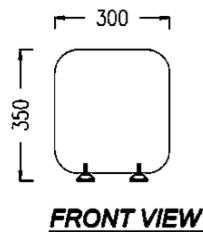
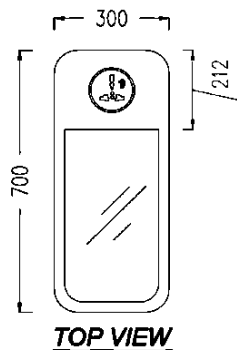

# Anello

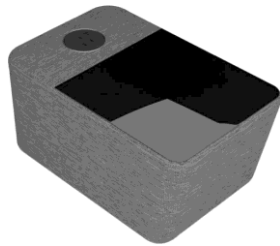

ANELLO Side Table with wire management  
Size: 450mm-L x 700mm-W x 350mm-HT  
Fabric : Forte

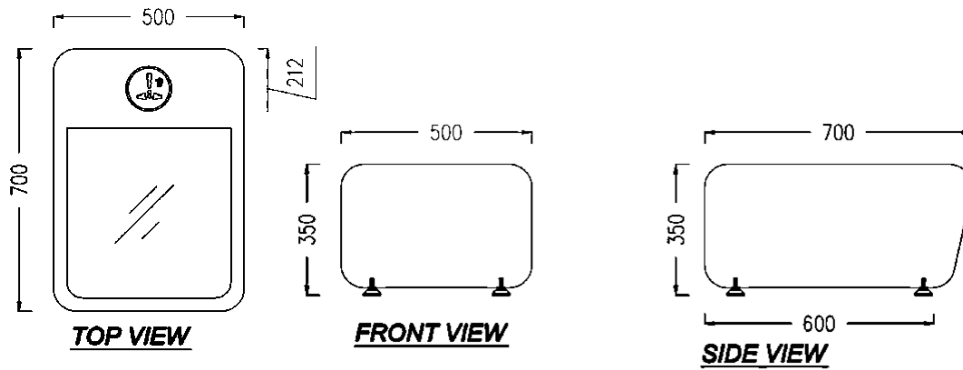



| Arco  
series



| Arco - Loop  
series

# Arco - Loop

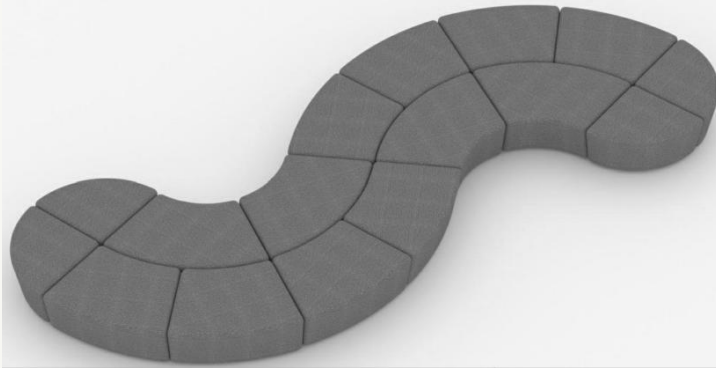

**ARCO-LOOP**  
Fabric : Forte

This sofa layout are flexible and can be customized to follow your design plan.

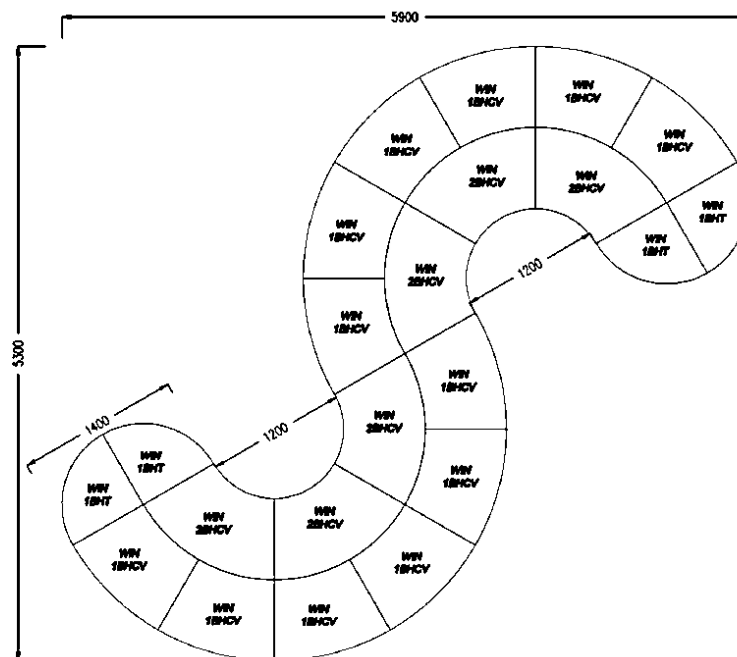



| Arco - C  
series

# Arco - C



## ARCO C -SHAPE SOFA COMBI

Size: 5200mm-L x 3900mm-W x 735mm-HT

Fabric : Forte

This sofa layout are flexible and can be customized to follow your design plan.

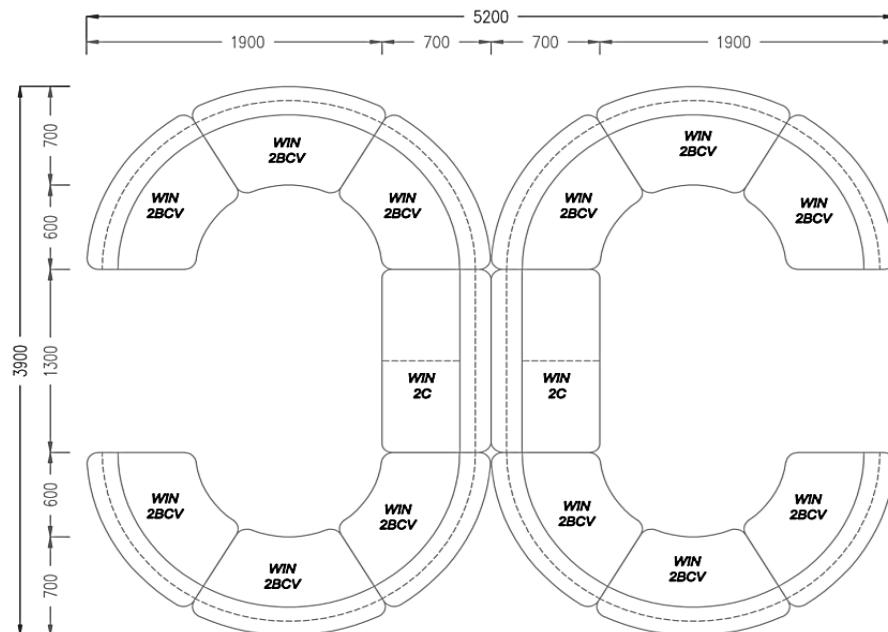



| Arco - Circle  
series

# Arco - Circle



## ARCO CIRCLE

Size: 2600mm-L x 2600mm-W x 735mm-HT

Fabric : Forte

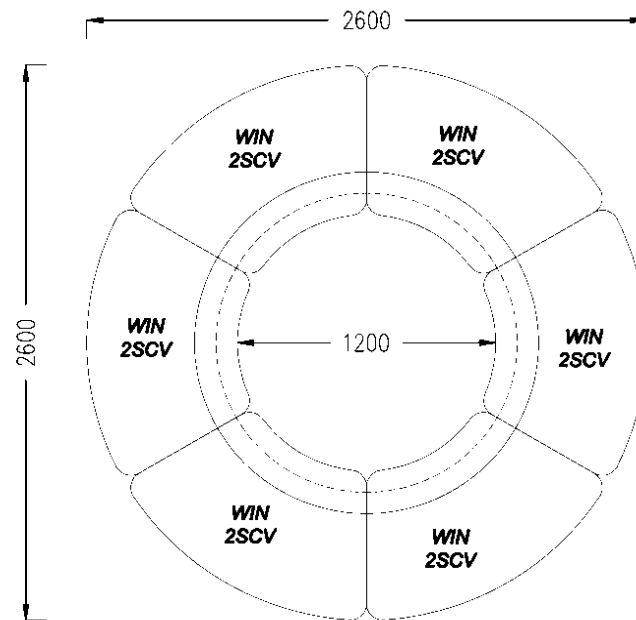

The Wintech Sofa Series are meticulously crafted with exceptional quality in mind. Every element, from the carefully chosen materials to the detailed fabric selection, is designed for lasting durability and comfort. The fabric is not only soft and luxurious but also selected for its resilience and timeless appeal. With a robust structure, the sofa is built to withstand everyday use, ensuring both long-lasting functionality and enduring style that will elevate any space.

# Quality Made

## Highlight Unique Features:

- Emphasize safety, comfort, and durability in marketing.

## Strengthen Quality Control:

- Implement consistent inspection across production stages.

## Innovate with Materials:

- Explore smart fabrics, ergonomic features, or modular designs.

## Enhance Customer Service:

- Provide care guides, maintenance tips, and responsive support.





130

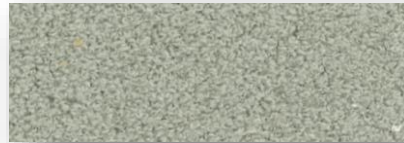

040

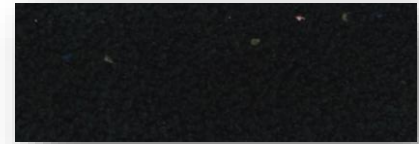

090



131

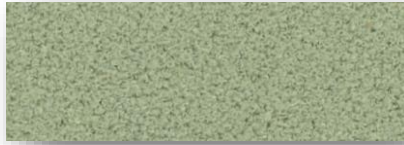

070



200



132



230



140



160



190



160



162



081



091



220

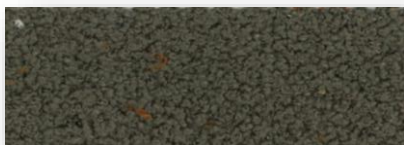

080

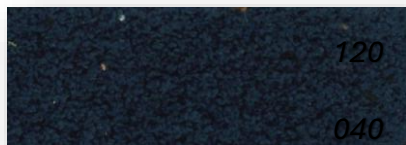

120

040



082

# FORTE Fabric Colour



WINTECH®

**Wintech Metal Processing Sdn Bhd**

180, Kawasan Perindustrian, Jalan 5 Kampung Olak Lempit,  
42700 Banting Selangor Darul Ehsan

+6012 282 8213 (Freddie) , +6012 2027008 (Dixon)

[enquiries@wintech.com.my](mailto:enquiries@wintech.com.my)

Copyright Wintech 2025